



An assurance of high-level healthcare thanks to the availability of electric power

Secure power distribution and monitoring solution for operating theatres

Schneider
Electric

24/24
7/7

Electric power constantly
available for the safety
of patients

Improving the performance of operating theatres...

To ensure the safety of patients, the availability and quality of electric power are essential. The electrical installations of operating theatres should enable the continuity of healthcare in all circumstances.

Enhancing patient safety

Ensuring the satisfactory operation of operating rooms is essential for a hospital.

Ensuring continuity of service

Because nothing must disturb the medical team during operations.

Improving the efficiency of hospital personnel

A controllable environment and perfectly functioning equipment mean more comfort and less stress for calmer work.

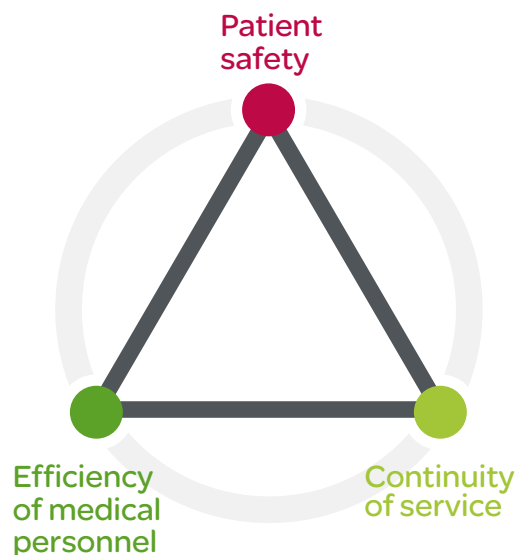

A reliable, efficient manufacturer's solution...

A manufacturer's solution...

- > All the components of this solution are **designed, manufactured** and **tested by Schneider Electric** to operate together and be implemented by trained and approved partners.
- > Schneider Electric proposes **maintenance plans** and **operating procedures** linked to this solution.
- > Schneider Electric ensures the **continuity of the components** throughout the installation's life.

... from secure power distribution...

- > The Schneider Electric solution incorporates an isolating transformer and a continuous insulation monitor in conformity with the required standards to ensure the power supply for medical equipment on first insulation fault.
- > The continuity of the electric power supply is ensured thanks to total coordination of all the Schneider Electric components and the uninterruptible power supply.
- > The Schneider Electric solution is designed, wired and tested to attenuate electromagnetic disturbances in accordance with the IEC 60364-4-44 standard.

... to event monitoring and traceability

The Schneider Electric solution incorporates a monitoring system to:

- > Inform maintenance personnel and medical personnel in real time in the event of an electrical fault in the operating room,
- > Monitor the operating room environment,
- > Record environmental events and data.



Schneider Electric is the global specialist in power management

Architectures

designed to ensure the availability of overall electricity distribution for the hospital.

Efficient **services** throughout the operation and life cycle of your installation.

Products

selected and installed to state-of-the-art standards, and coordinated with one another.

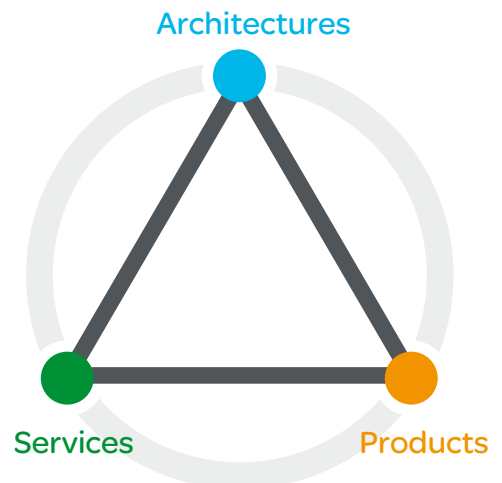

... tested, in compliance with the standards and regulations in force



IEC

Our solution complies with international standard IEC 60364-7-710 and national standards and regulations

What do the standards say?

- > In group 2* rooms for medical use, **the medical IT system**** should be used for the circuits powering medical electrical equipment and systems for survival and surgical applications, and the other equipment located in the environment of the patient.
- > An **audible and visual alarm** must be provided for in the room in question to alert medical personnel.
- > Operating activities must have **continuity of electric power supply**.
- > For the satisfactory operation of medical equipment, **prevention of electromagnetic disturbances** may be necessary.

* Group 2 (according to IEC 60364-7-710): rooms for medical applications in which the parts applied are designed to be used in applications such as intracardiac procedures, operative fields and vital treatments where discontinuity (failure) of the power supply could entail danger for life.

** The medical IT system does not require automatic cutoff of the power supply whenever an insulation fault occurs. In this type of system, the exposed conductive parts of the installation are connected to the installation's neutral point.

A power distribution and monitoring solution to meet the needs of all users

Our solution offers an optimal level of safety and comfort for both medical personnel and maintenance personnel. Everyone can concentrate on their jobs and optimise their work.



The nurse

- > tests the insulation monitoring system at start-up of the operating room,
- > is warned of an electrical fault or insulation fault,
- > uses **the Magelis touch screen panel** to monitor environmental,
- > is notified of any work performed by maintenance personnel,
- > generates an insulation test.

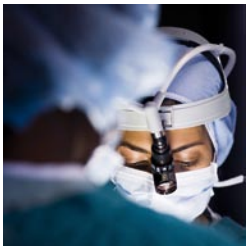

The surgeon

- > remains concentrated on what is essential, his/her patient,
- > benefits from the stability and security of the electric power supply.

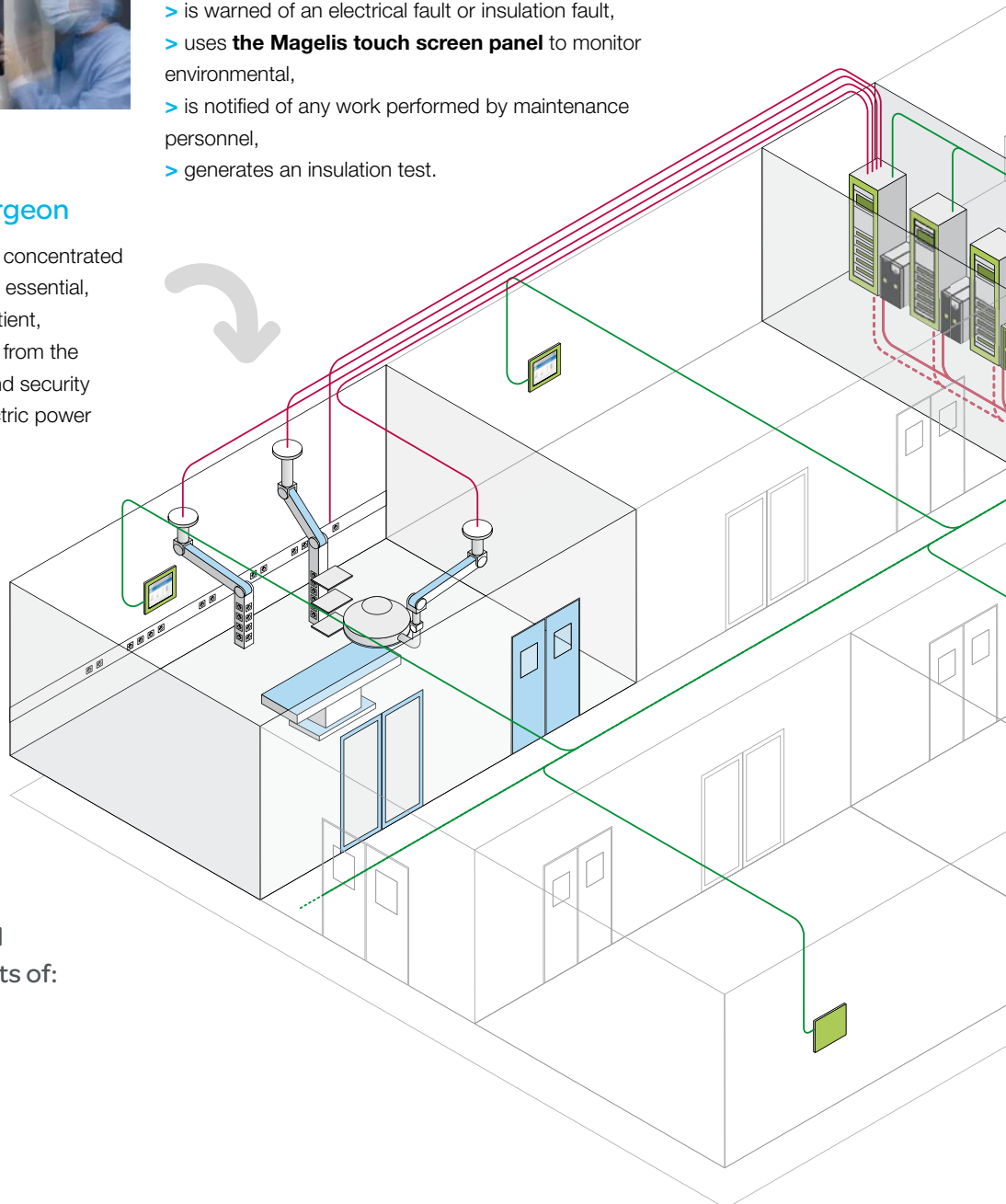

Our power distribution and monitoring solution consists of:

- a switchboard,
- a monitoring system,
- an uninterruptible power supply.

g solution

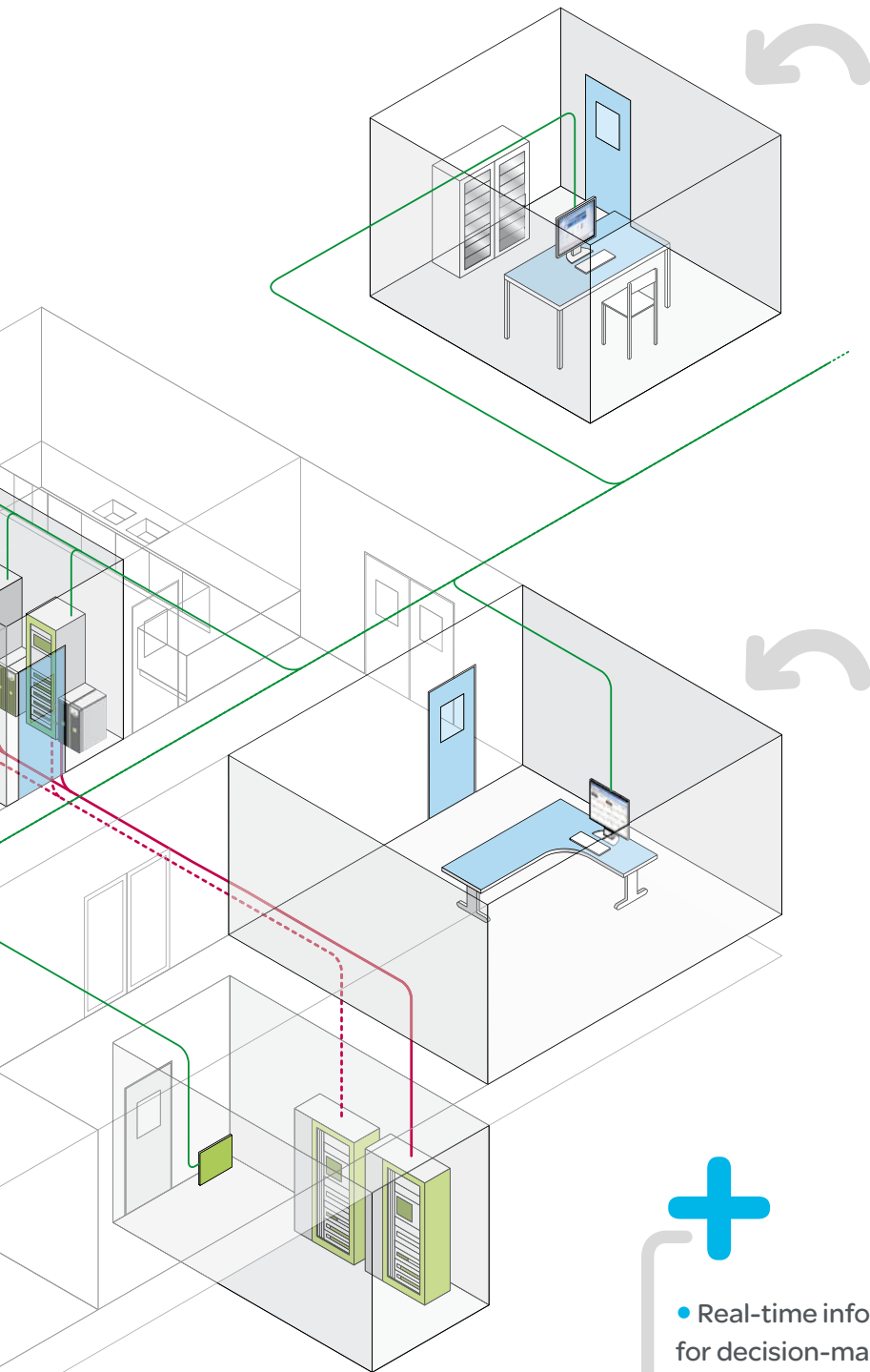

The maintenance personnel

- > is notified by SMS message of the presence of an electrical fault in an operating room,
- > consults via its PC the electrical state of each operating room,
- > performs servicing on the cabinet indicated as at fault,
- > can indicate its handling of the fault.

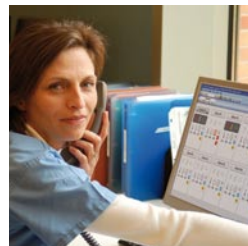

The supervision personnel

- > views the states of each operating room on its PC,
- > generates event reports,
- > sets alarm thresholds for the temperature and relative humidity values of operating rooms.



- Real-time information for decision-making and action
- Traceability of event
- Monitoring of each operating room
- Continuity of service for patient safety

An electrical distribution cabinet de with the best equipment from Schn

Organized by zones for efficient servicing operations
and to prevent electromagnetic disturbances.

Prisma Plus switchboard

- > Physical separation between zones,
- > Pivoting front panels,
- > Separation of weak currents and heavy currents,
- > Power distribution by distribution blocks with spring terminals.

1

Connection zone for outgoing and incoming cables

- > The terminals are grouped together in 3 zones identified by labels.



- Servicing operations on connections limited to a single zone
- Clear markings for servicing operations

2

Data acquisition and communication zone

- > Real-time monitoring of the state of circuit breakers, the insulation level and the transformer of the IT system,
- > Acquisition of temperature, pressure and relative humidity values for the operating room and comparison with thresholds,
- > Information on medical gas states,
- > Data and alarm transmission to the touch screen panel in the operating room and to the supervision and maintenance PCs.



- Protection of operators against direct contact
- Servicing operations limited only to the zones concerned
- Protection from electromagnetic disturbances, in accordance with IEC 60364-4-41, IEC 61000-6-2 and -6-3
- Continuity of service and long service life with high-quality electrical contacts



- Communication protocols LON, Modbus and TCP/IP open to connection to the hospital network

1

2

3

4

5



signed eider Electric

3

TNS system feeder zone

- > Isolation switch-disconnector for maintenance operations,
- > C60L circuit breakers with magnetic trip units for non-critical feeders with failsafe contact for electrical fault detection,
- > Backed-up 24 VDC power supply (battery life 1 hour) for the touch screen panel in the operating room and the data acquisition system.



- Reliable fault detection on feeders
- Data monitoring system and touch screen panel in operating theatre backed up for 1 hour

4

IT system feeder zone and insulation monitoring

- > EM9BV insulation monitor in compliance with the IEC 61557-8 standard and the requirements of the IEC 60364-7-710 standard,
- > C60N circuit breakers with magnetic trip units for critical feeders with failsafe contact for electrical fault detection.



- No power cutoff on first fault
- Permanent digital display of insulation value
- Fault indication by failsafe contact

5

Isolating transformer zone, 6.3/8 and 10 kVA

- > Isolating transformer for IT system in compliance with IEC 61558-2-15:
 - Strengthened galvanic isolation between primary and secondary: 100 MOhms,
 - Leakage current between secondary and frame: < 0.5 mA,
 - Limited inrush current: < 12 In,
 - Low no-load current and reduced voltage drop under load (< 3%),
- > Temperature monitoring by sensor and overload monitoring by thermal relay.

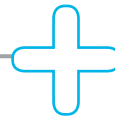

- No electric shock for patients
- Stability of medical instrumentation power supply
- No cabinet ventilation, no noise

6

Uninterruptible power supply

- > Protects the switchboard against mains power cuts, voltage dips and overvoltages,
- > Filters slight current fluctuations and isolates the switchboard from major mains disturbances,
- > The UPS ensures a power supply until the mains supply returns to normal (standby power supply at full load: 10 minutes).



- Quality of electric power supply
- Continuity of service

6

A monitoring system...

With its monitoring system, our solution provides access to all information concerning the electrical and environmental state of rooms.

> Personnel in operating room



Magelis touch screen panel

- > Visual and audible indications of electrical faults,
- > Audible alarm stoppage,
- > Display of environmental parameters and state of medical gases,
- > Information on fault handling by the maintenance personnel,
- > Testing of the insulation monitoring system.

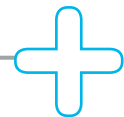

- Be informed to take decisions

> Supervision personnel



PC with the supervision system software pre-installed

- > Display of parameters for each operating room,
- > Backup of electrical events and environmental parameters and report printout,
- > Temperature and pressure threshold setting.

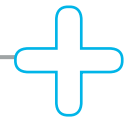

- Event traceability

> Maintenance personnel



PC with a Web browser

- > Display of parameters for each operating room,
- > The medical team is notified of handling of a fault.

Alarm by SMS message



- Be informed in order to take action
- Reassure the medical team

... for information in real time

> 15" Magelis touch screen panel

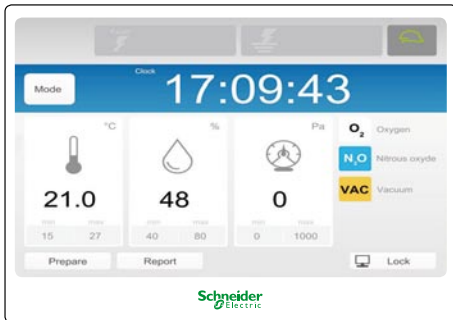

Welcome page

- > Time,
- > Display of temperature, relative humidity, pressure and state of medical gases (O₂, N₂O and vacuum),
- > Hours/minutes/seconds display,
- > Access to other functions and locking of the touch screen panel.

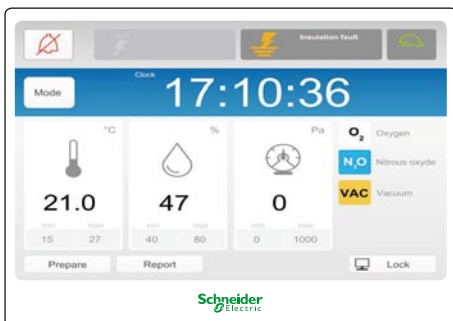

Insulation fault

- > Electrical and insulation fault indication,
- > Indication of fault handling by the maintenance personnel,
- > Audible alarm stoppage.

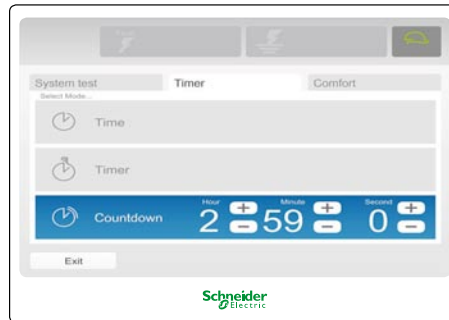

Time management

- > Timer, chronometer.

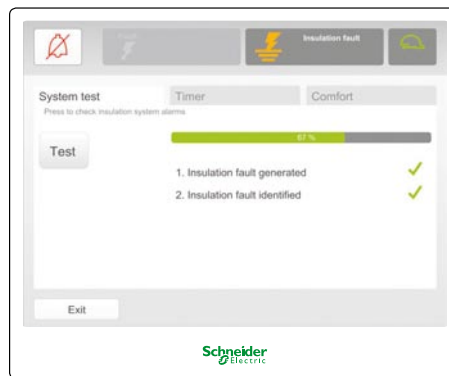

Testing of insulation monitor

- > Verification of the insulation monitoring system.

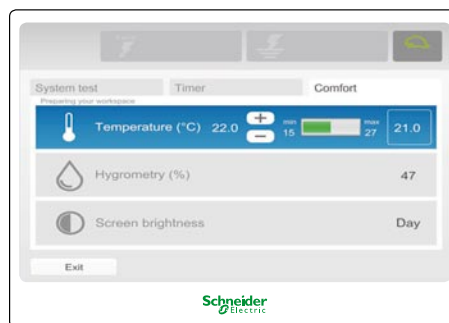

Environmental management

- > Temperature and relative humidity value setting,
- > Day/night screen lighting.

> Vigilohm HRP: an alternative to Magelis



Simple and efficient

- > Audible and visual alarm for an insulation or electrical fault (transformer overload or circuit breaker tripping),
- > Testing of the insulation monitoring system,
- > Audible alarm stoppage.



- Flush
- Antibacterial
- Resistant to cleaning products

1 coherent electrical system architecture dedicated to continuity of service

- > An uninterruptible power supply for quality of power,
- > A changeover switch in the event of loss of the UPS and for maintenance,
- > Total coordination between equipment contributes to long life and continuity of service of the installation.

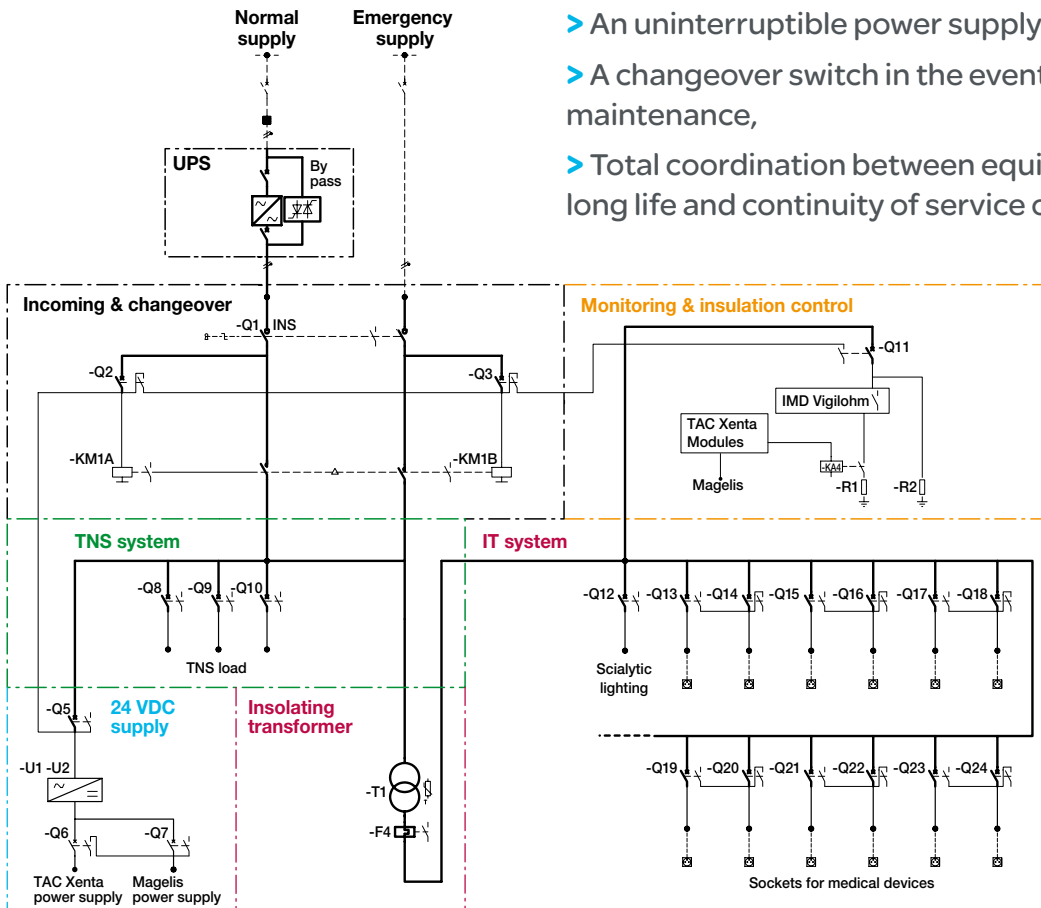



- Electrical system architecture consistent with equipment and a distribution system from a single manufacturer
- Interoperability with the hospital's electrical system architecture thanks to Schneider Electric equipment

3 levels of information for the monitoring system

The Schneider Electric offer		Classic	Advanced	Full
Control and signalling panel	Type of display	Vigilohm HRP	Magelis touch screen panel	Magelis touch screen panel
	State of temperature, pressure, relative humidity, medical gases	-	Yes	Yes
Maintenance access	Access to operating theatre data	-	Yes	Yes
	SMS alarm	-	-	Yes
Supervision personnel access	Access to operating theatre data	-	-	Yes
	Event traceability	-	-	Yes
	Event report	-	-	Yes
UPS	If normal power supply not backed up	Yes	Yes	Yes

2 cabinet sizes depending on the space available

Prisma Plus P enclosure

- > Integrated transformer
- > Floor mounting

Height	Width	Depth
2206 mm	856 mm	450 mm

Prisma Plus G floor standing enclosure

- > External transformer with IP21/IK07 cover
- > Floor or wall mounting

Height	Width	Depth
1830 mm	900 mm	243 mm

Transformers with IP21/IK07 cover

Power	Height	Width	Depth
6,3/8 kVA	710 mm	470 mm	540 mm
10 kVA	740 mm	470 mm	540 mm



Uninterruptible power supply

Power	Height	Width	Depth
8/10 kVA	432 mm	263 mm	736 mm



EMC

Conformity with the IEC 60364-4-44 standard thanks to the low level of equipment emissivity and sensitivity, and the cabling rules applied

Technical characteristics

Electrical characteristics

Operational voltage: 230V / 50-60 hz

Isc: 25 kA

In: 63 A maximum

Environmental conditions

(Operating room or electrical premise)

Location	indoor
Altitude	< or = 2 000 m
Maximum ambient air temperature	30°C
Relative humidity	90%
Switchboard power losses	465 W

Electrical switchboard enclosure: Prisma Plus

Steel sheet, Cataphoresis treatment + hot-polymerized polyester epoxy powder, RAL 9001 colour

Degree of protection	IP30
Degree of protection against mechanical shocks	IK07
Ventilation	Natural ventilation
Cable inlets and outlets	In duct, through the bottom or top
Cable connection	To terminals

IT system feeders

Isolating transformer	6.3/8 or 10 kVA with temperature sensor and overload monitoring
EM9BV insulation monitor + display of insulation value	- Internal resistance in alternating current: 100 kΩ - Injection voltage: 24 VDC max. - Injected current: 240 µA dc max. - Fault indication threshold setting: 50 kΩ.
C curve C60N circuit breakers	Up to 24 feeders on 3 rows (protection for 1 or 3 power outlets per feeder)

TNS system feeders

C curve C60L circuit breakers	Up to 6 feeders
-------------------------------	-----------------

Monitoring

Data acquisition and communication modules	TAC Xenta 731, 421, 321
Protocols	LonWorks, LonMark, Modbus and TCP/IP
Temperature, pressure and relative humidity sensors	Schneider Electric
Data backup time	1 hour
Magelis touch screen panel	15" backlit active-matrix TFT LCD tested with Anios products
Vigilohm HRP	Plastic case: IP54, IK10 Tested with Anios products

Conformity with standards

Switchboard	IEC 60364-7-710 IEC 61439-1 and -2
Isolating transformer	IEC 61558-2-15
Continuous insulation monitor	IEC 61557-8
Electromagnetic compatibility	IEC 60364-4-44 IEC 61000-6-2 and -3

Uninterruptible power supply

Efficiency at full load	98 %
Output voltage distortion	< 3 %
Standard duration of power supply at full load	5 mn

High-value-added services

Throughout the world, our Schneider Electric Service experts and our local partners are attentive to your needs and propose to you a comprehensive and unique service offering.

Expert services

For improved installation performance...

- > Energy efficiency,
- > Installation reliability and safety,
- > Reduced capital expenditure,
- > Reduced power consumption,
- > Reduction in the number of failures,
- > Reduction in downtime and repair time,
- > Training of operation and maintenance teams,
- > Longer equipment service life.

... Over the entire life cycle of the installation

- > Installation design,
- > Commissioning,
- > Operating aid,
- > Maintenance and revamping,
- > Energy efficiency audit,
- > Customized services.

Customer support and online services

- > Call centres, online diagnosis services and technical assistance,
- > Services via Internet: electronic catalogues, downloadable software, information and training.

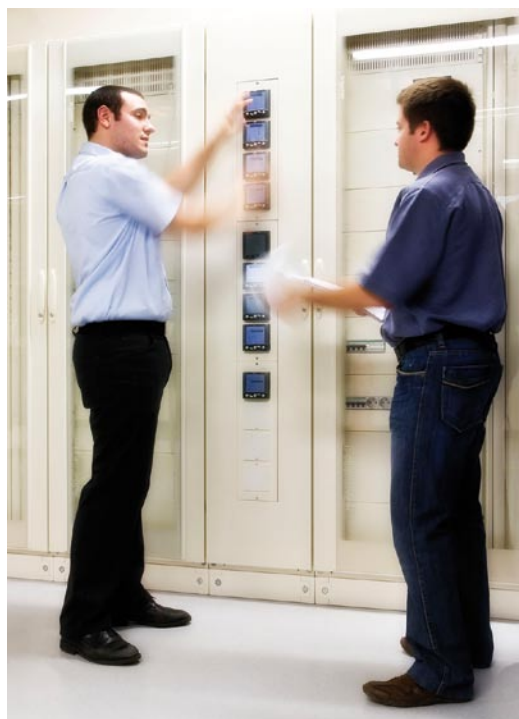

In Search of Excellence

Schneider Electric conducts an ambitious innovation, quality and efficiency policy:

- > Around 5% of turnover is invested in R&D,
- > 6,500 researchers and developers.

A close relationship with our customers

> A strong international footprint with 105,000 employees in 130 countries. With our partners, distributors, panelbuilders, contractors and engineering offices, we want to establish with you a relationship of trust and help you achieve an optimal level of performance.

A strong social commitment

- > Sustainable development is key in Schneider Electric's strategy. Our solutions help those without electricity obtain access to it and favour a reduction in energy consumption by both industrial firms and private consumers.
- > 91% of our plants are certified ISO 14001. The Schneider Electric product offering complies with all existing standards worldwide.

> Make the most of your energy

Schneider Electric Industries SAS

Head Office
35, rue Joseph Monier - CS30323
F92505 Rueil-Malmaison Cedex
FRANCE

www.schneider-electric.com

Due to possible changes in standards and equipment, the features described in this document in the form of text and images are subject to confirmation by Schneider Electric.

Publication: Schneider Electric

Design: pemaco

Photos: Nicole Hill - Gettyimages, Beerkof - Shutterstock, Patrick Avavian, Schneider Electric, Naomi Bassitt - Istockphoto

Illustration: Pemaco

Printing: